













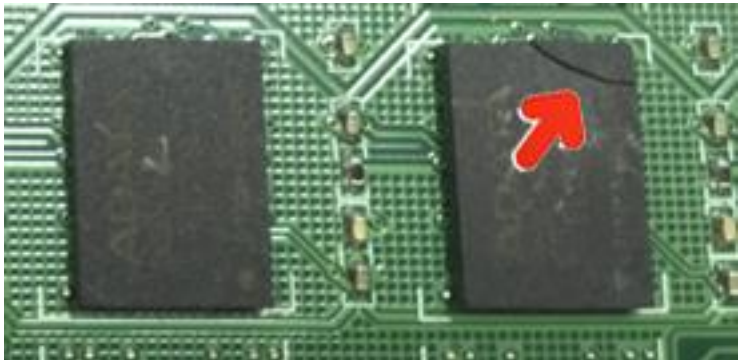

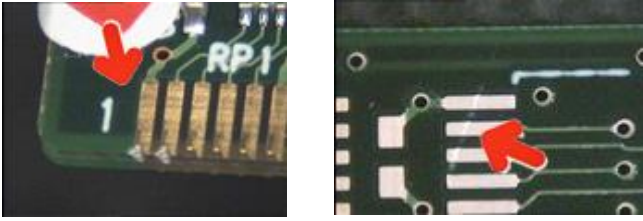
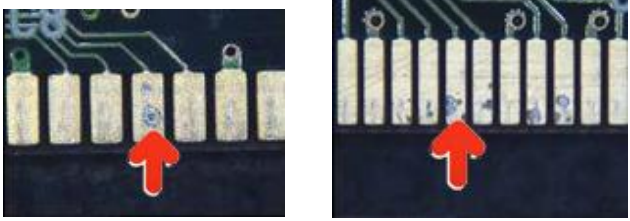
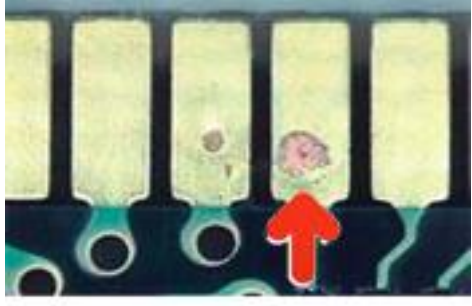



Moduli DRAM

Descrizione	immagine
<p>I danni derivanti da uso improprio: etichettatura insolita. (Etichette di codici a barre deturpati o non chiare. Angoli che sono piegati o strappi dell'etichetta).</p>	
<p>Nessuna etichetta di garanzia ADATA</p>	
<p>Etichetta inclinata</p>	
<p>Condensatore mancante</p>	
<p>Rottura componente</p>	

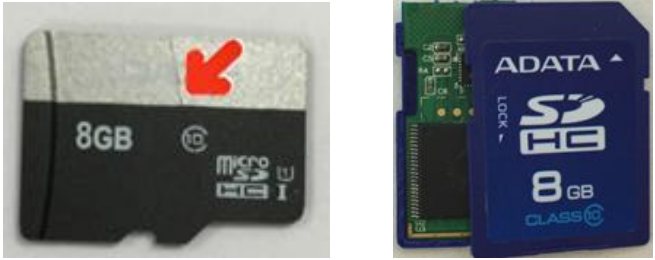
<p>Perdita componente.</p>	
<p>Bordo scheda sfaldato.</p>	
<p>Danno imposto sulla scheda PCB.</p>	
<p>Erosione componente dovuto a umidità o esposizione ad un ambiente oltre le specifiche del prodotto.</p>	
<p>Esposizione del connettore.</p>	

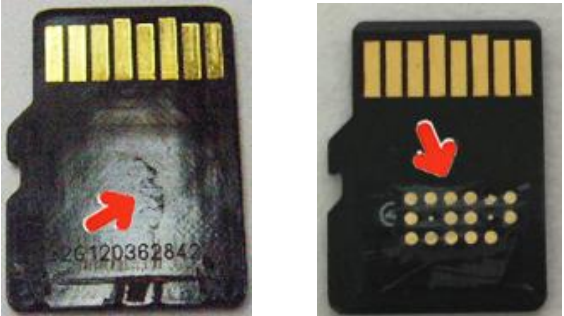
<p>Combustione del connettore (a volte accompagnata da surriscaldamento PCB).</p>	
<p>Graffi profondi connettore</p>	
<p>Graffi/corrosione connettore</p>	

<h3>Schede di memoria</h3>	
<p>Descrizione</p>	<p>immagine</p>
<p>Prodotto contraffatto: metodi di marcatura non utilizzati da ADATA.</p>	
<p>Prodotto contraffatto: metodi di marcatura laser non utilizzati da ADATA.</p>	

<p>Danni derivanti da uso improprio: flessione o frattura.</p>	
<p>Danni derivanti da uso improprio: scheggiatura.</p>	
<p>Danni derivanti da uso improprio: forte abrasione del case, esposizione dei componenti.</p>	
<p>Danni derivanti da uso improprio: abrasione/ossidazione connettore</p>	
<p>Danni derivanti da uso improprio: perdita del fermaglio blocco scrittura</p>	
<p>Danni derivanti da uso improprio: danni connettore/connettore.</p>	

<p>Articoli non commerciali: articoli etichettati "Sample" ("Campione").</p>	
--	--

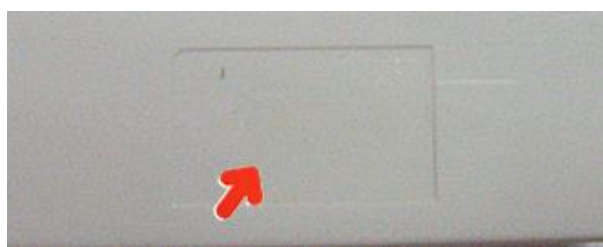
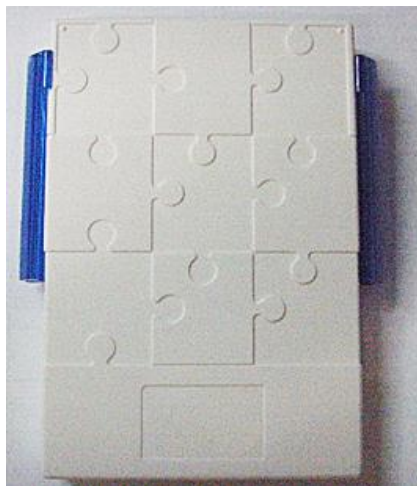

<p style="text-align: center;">Storage Esterno</p>	
<p>Descrizione</p>	<p>immagine</p>
<p>I danni derivanti da uso improprio: danno per l'aspetto del prodotto, incluso ma non limitato a danni che non possono influenzare la funzionalità essenziale del prodotto.</p>	

I danni derivanti da uso improprio: danni derivati dalla rimozione di, abrasione, contatto con etichette o danni alle etichette ottenute durante il corso di uso del prodotto.



Dischi stato solido SSD

Descrizione	immagine
<p>Adesivi fragili danneggiati (Fori per le viti adesivi fragili danneggiati, deformati o strappati)</p>	
<p>Depressione aspetto (Alloggiamento SSD depressione anomalo)</p>	

	 <p>WARNING DELICATE PRODUCT DAMAGE MAY OCCUR IF SHOCK TOUCHING THE CIRCUITS MAY REMOVAL OF THIS COVER W</p> <p>Acronis ATI HD PGCJH4X-9N</p> <p>FC CE</p> <p>VCI</p> <p>WARRANTY VOID IF REMOVED</p>
<p>Scambio pezzi SSD (caduta anomala componenti prodotto mSATA)</p>	 <p>00 64GB L-C</p> <p>001 REMOVED</p>
<p>Connettore anomalo (Rottura connettore/frattura inclinazione anomala piedino)</p>	